

ANTAMINE INOX 304

# THANH NẠP INOX 304

Với nhu cầu phụ kiện trang trí và thi công cho tấm ốp tường chống cháy, chúng tôi hợp tác với các nhà sản xuất phụ kiện Inox 304 nổi tiếng trên thế giới để cải tiến mẫu mã, đưa ra các thiết kế đẹp nhất. Các sản phẩm của chúng tôi khá phổ biến trên thế giới như Mỹ, Tây Ban Nha, Italia, các nước châu Âu khác, Trung Đông,...chúng được đánh giá rất cao bởi những người tiêu dùng, các nhà thiết kế, nhà thầu,...



Màu sắc  
Color option



1S: Silver Shiny / Bạc bóng



1B: Silver Brushed / Bạc xước



2S: Gold Shiny / Vàng bóng

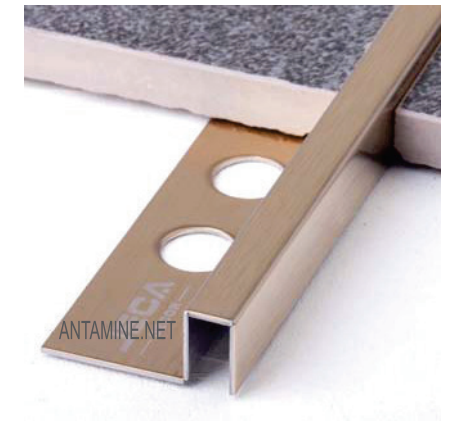

2B: Gold Brushed / Vàng xước



3S: Rose Gold Shiny / Vàng đỏ bóng



3B: Rose Gold Brushed / Vàng đỏ xước



4S: Black Shiny / Đen bóng

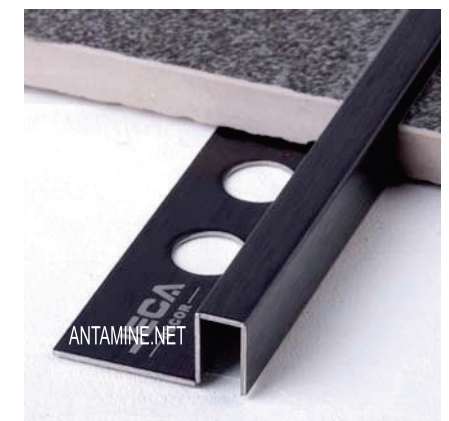

4B: Black Brushed / Đen xước

## Decorative Profiles Thanh trang trí

For floor or wall decoration.

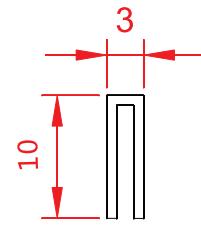
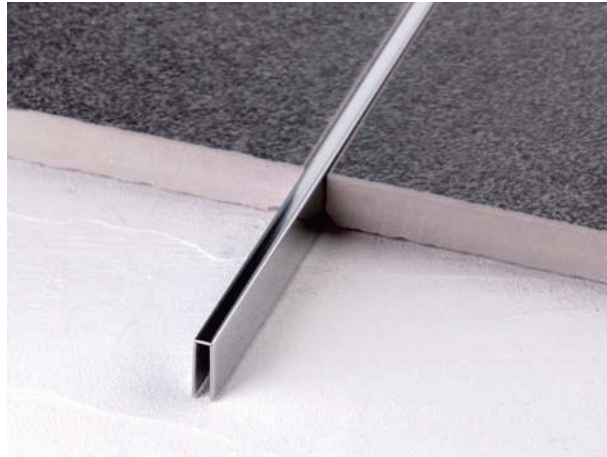

**SUP03**

Stainless Steel 304/316 304 316

ART.	Hight (mm)	Length (mm)	Thickness (mm)	Color	Remark
SUP031	10	2440	0.8	Silver Shiny	Sizes can be customized. Kích thước có thể theo yêu cầu Max: 3000mm
SUP032	10	2440	0.8	Gold Shiny	
SUP033	10	2440	0.8	Rose Gold Shiny	
SUP034	10	2440	0.8	Black Shiny	
SUP035	10	2440	0.8	Silver Brushed	
SUP036	10	2440	0.8	Gold Brushed	
SUP037	10	2440	0.8	Rose Gold Brushed	
SUP038	10	2440	0.8	Black Brushed	

## Decorative Profiles

For floor or wall decoration.

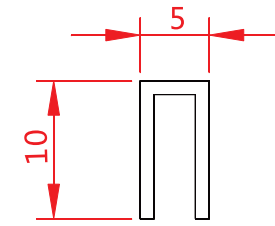

**SUP05**

Stainless Steel 304/316 不锈钢304/316

ART.	Hight (mm)	Length (mm)	Thickness (mm)	Color	Remark
SUP051	10	2440	0.8.1.0	Silver Shiny	Sizes can be customized.
SUP052	10	2440	0.8.1.0	Gold Shiny	
SUP053	10	2440	0.8.1.0	Rose Gold Shiny	
SUP054	10	2440	0.8.1.0	Black Shiny	
SUP055	10	2440	0.8.1.0	Silver Brushed	
SUP056	10	2440	0.8.1.0	Gold Brushed	
SUP057	10	2440	0.8.1.0	Rose Gold Brushed	
SUP058	10	2440	0.8.1.0	Black Brushed	

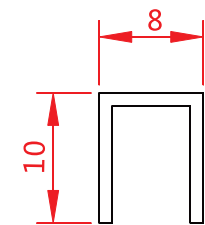

**SUP08**

Stainless Steel 304/316 304 316

ART.	Hight (mm)	Length (mm)	Thickness (mm)	Color	Remark
SUP081	10	2440	0.8.1.0	Silver Shiny	Sizes can be customized.
SUP082	10	2440	0.8.1.0	Gold Shiny	
SUP083	10	2440	0.8.1.0	Rose Gold Shiny	
SUP084	10	2440	0.8.1.0	Black Shiny	
SUP085	10	2440	0.8.1.0	Silver Brushed	
SUP086	10	2440	0.8.1.0	Gold Brushed	
SUP087	10	2440	0.8.1.0	Rose Gold Brushed	
SUP088	10	2440	0.8.1.0	Black Brushed	

# Decorative Profiles Thanh trang trí

For floor or wall decoration.

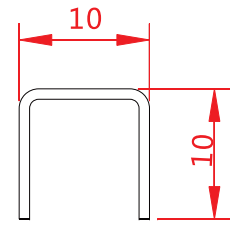

**SU10**

Stainless Steel 304/316 不锈钢304/316

ART.	Hight (mm)	Length (mm)	Thickness (mm)	Color	Remark
SU101	10	2440	0.6, 0.8	Silver Shiny	Sizes can be customized.
SU102	10	2440	0.6, 0.8	Gold Shiny	
SU103	10	2440	0.6, 0.8	Rose Gold Shiny	
SU104	10	2440	0.6, 0.8	Black Shiny	
SU105	10	2440	0.6, 0.8	Silver Brushed	
SU106	10	2440	0.6, 0.8	Gold Brushed	
SU107	10	2440	0.6, 0.8	Rose Gold Brushed	
SU108	10	2440	0.6, 0.8	Black Brushed	

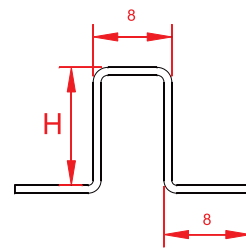

**SB030**

Stainless Steel 304/316 304 316

ART.	Hight (mm)	Length (mm)	Thickness (mm)	Color	Remark
SB030-8H	8	2440	0.6, 0.8, 1.0	1S, 2S, 3S, 4S, 1B, 2B, 3B, 4B	Sizes can be customized.
SB030-10H	10	2440	0.6, 0.8, 1.0	Color option refer to P2.	
SB030-12H	12	2440	0.6, 0.8, 1.0	P2	

# Decorative Profiles

For floor or wall decoration.



**SU15**

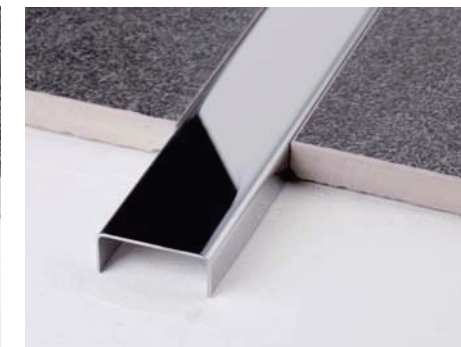

**SU25**

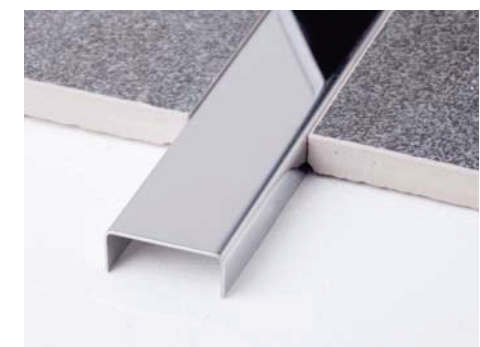

**SU30**

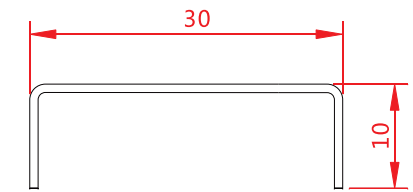
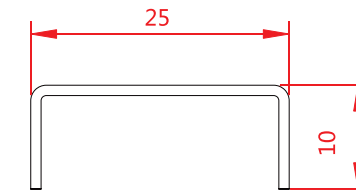
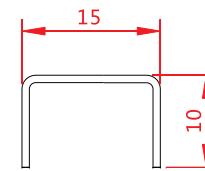

Stainless Steel 304/316

ART.	Hight (mm)	Length (mm)	Thickness (mm)	Color	Remark
SU151	10	2440	0.6, 0.8	Silver Shiny	Sizes can be customized.
SU152	10	2440	0.6, 0.8	Gold Shiny	
SU153	10	2440	0.6, 0.8	Rose Gold Shiny	
SU154	10	2440	0.6, 0.8	Black Shiny	
SU155	10	2440	0.6, 0.8	Silver Brushed	
SU156	10	2440	0.6, 0.8	Gold Brushed	
SU157	10	2440	0.6, 0.8	Rose Gold Brushed	
SU158	10	2440	0.6, 0.8	Black Brushed	
SU251	10	2440	0.6, 0.8	Silver Shiny	Sizes can be customized.
SU252	10	2440	0.6, 0.8	Gold Shiny	
SU253	10	2440	0.6, 0.8	Rose Gold Shiny	
SU254	10	2440	0.6, 0.8	Black Shiny	
SU255	10	2440	0.6, 0.8	Silver Brushed	
SU256	10	2440	0.6, 0.8	Gold Brushed	
SU257	10	2440	0.6, 0.8	Rose Gold Brushed	
SU258	10	2440	0.6, 0.8	Black Brushed	
SU301	10	2440	0.6, 0.8	Silver Shiny	Sizes can be customized.
SU302	10	2440	0.6, 0.8	Gold Shiny	
SU303	10	2440	0.6, 0.8	Rose Gold Shiny	
SU304	10	2440	0.6, 0.8	Black Shiny	
SU305	10	2440	0.6, 0.8	Silver Brushed	
SU306	10	2440	0.6, 0.8	Gold Brushed	
SU307	10	2440	0.6, 0.8	Rose Gold Brushed	
SU308	10	2440	0.6, 0.8	Black Brushed	

# Tile Edging Profiles Thanh mép

(For floor or wall edges decorative or protection)

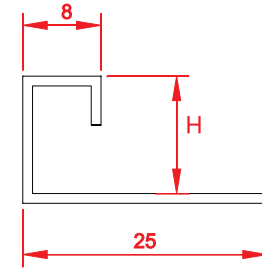

**SBP024**

Stainless Steel 304/316      304 316

ART.	Hight (mm)	Length (mm)	Thickness (mm)	Color	Remark
SBP024-8H	8	2440	0.6, 0.8, 1.0	1S, 2S, 3S, 4S, 1B, 2B, 3B, 4B	Sizes can be customized.
SBP024-10H	10	2440	0.6, 0.8, 1.0	Color option refer to P2.	
SBP024-12H	12	2440	0.6, 0.8, 1.0	P2	



# Tile Edging Profiles

For floor or wall edges decorative or protection.

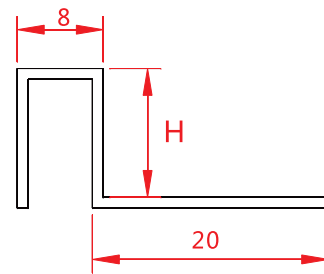

**SB017**

Stainless Steel 304/316      304 316

ART.	Hight (mm)	Length (mm)	Thickness (mm)	Color	Remark
SB017-8H	8	2440	0.6, 0.8, 1.0	1S, 2S, 3S, 4S, 1B, 2B, 3B, 4B	Sizes can be customized.
SB017-10H	10	2440	0.6, 0.8, 1.0	Color option refer to P2.	
SB017-12H	12	2440	0.6, 0.8, 1.0		

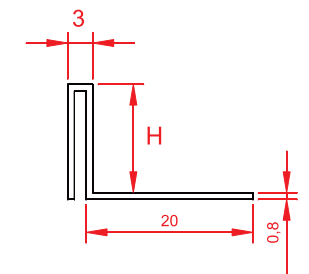

**SB018**

Stainless Steel 304/316      304 316

ART.	Hight (mm)	Length (mm)	Thickness (mm)	Color	Remark
SB018-8H	8	2440	0.8	1S, 2S, 3S, 4S, 1B, 2B, 3B, 4B	Sizes can be customized.
SB018-10H	10	2440	0.8	Color option refer to P2.	
SB018-12H	12	2440	0.8	P2	

# Tile Edging Profiles Thanh cạnh

For floor or wall edges decorative or protection

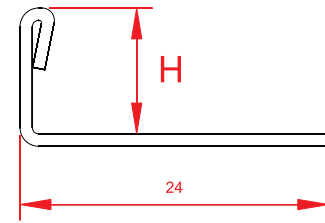

**SL005**

Stainless Steel 304/316      304 316

ART.	Hight (mm)	Length (mm)	Thickness (mm)	Color	Remark
SL005-6H	6	2440	0.6, 0.8, 1.0	1S, 2S, 3S, 4S, 1B, 2B, 3B, 4B  Color option refer to P2.	Sizes can be customized.
SL005-8H	8	2440	0.6, 0.8, 1.0		
SL005-10H	10	2440	0.6, 0.8, 1.0		
SL005-12H	12	2440	0.6, 0.8, 1.0		
SL005-12.5H	12.5	2440	0.6, 0.8, 1.0		
SL005-15H	15	2440	0.6, 0.8, 1.0		

# Tile Edging Profiles Thanh cạnh

For floor or wall edges decorative or protection

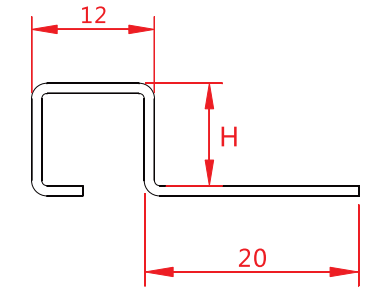

**SB014**

Stainless Steel 304/316      304 316

ART.	Hight (mm)	Length (mm)	Thickness (mm)	Color	Remark
SB014-8H	8	2440	0.6, 0.8, 1.0	1S, 2S, 3S, 4S, 1B, 2B, 3B, 4B	Sizes can be customized.
SB014-10H	10	2440	0.6, 0.8, 1.0	Color option refer to P2.	
SB014-12H	12	2440	0.6, 0.8, 1.0	P2	

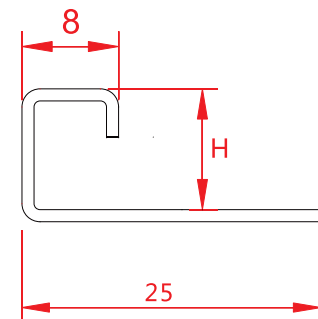

**SB013**

Stainless Steel 304/316      304 316

ART.	Hight (mm)	Length (mm)	Thickness (mm)	Color	Remark
SB013-8H	8	2440	0.6, 0.8, 1.0	1S, 2S, 3S, 4S, 1B, 2B, 3B, 4B  Color option refer to P2.	Sizes can be customized.
SB013-10H	10	2440	0.6, 0.8, 1.0		
SB013-12H	12	2440	0.6, 0.8, 1.0		

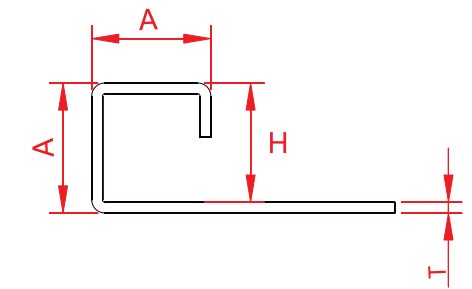

**SB016**

Stainless Steel 304/316      304 316

ART.	Hight (mm)	Length (mm)	Thickness (mm)	Color	Remark
SB016-8H	8	2440	0.6, 0.8, 1.0	1S, 2S, 3S, 4S, 1B, 2B, 3B, 4B  Color option refer to P2.	Sizes can be customized.
SB016-10H	10	2440	0.6, 0.8, 1.0		
SB016-11H	11	2440	0.6, 0.8, 1.0		
SB016-12H	12	2440	0.6, 0.8, 1.0		

# Tile Edging Profiles Thanh cạch

For floor or wall edges decorative or protection

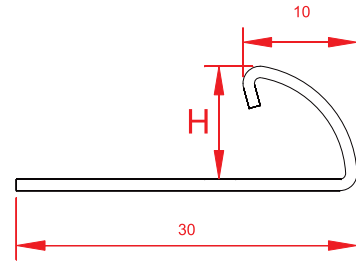

**SR003**

Stainless Steel 304/316      304 316

ART.	Hight (mm)	Length (mm)	Thickness (mm)	Color	Remark
SR003-8H	8	2440	0.6, 0.8, 1.0	1S, 2S, 3S, 4S, 1B, 2B, 3B, 4B	Sizes can be customized.
SR003-10H	10	2440	0.6, 0.8, 1.0	Color option refer to P2.	
SR003-12H	12	2440	0.6, 0.8, 1.0	P2	

# Tile Edging Profiles Thanh cạch

For floor or wall edges decorative or protection

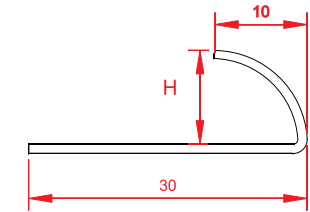

**SR001**

Stainless Steel 304/316      304 316

ART.	Hight (mm)	Length (mm)	Thickness (mm)	Color	Remark
SR001-10H	10	2440	0.6, 0.8, 1.0	1S, 2S, 3S, 4S, 1B, 2B, 3B, 4B	Sizes can be customized.
SR001-12H	12	2440	0.6, 0.8, 1.0	Color option refer to P2.	
SR001-14H	14	2440	0.6, 0.8, 1.0	P2	

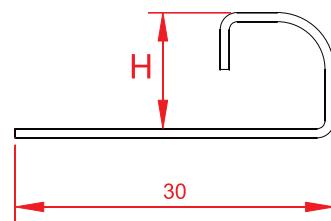

**SR029**

Stainless Steel 304/316      304 316

ART.	Hight (mm)	Length (mm)	Thickness (mm)	Color	Remark
SR029-8H	8	2440	0.6, 0.8, 1.0	1S, 2S, 3S, 4S, 1B, 2B, 3B, 4B	Sizes can be customized.
SR029-10H	10	2440	0.6, 0.8, 1.0	Color option refer to P2.	
SR029-12H	12	2440	0.6, 0.8, 1.0	P2	



# Corner Protection Profiles Thanh bảo vệ góc

For wall corner covers



**SBP110**

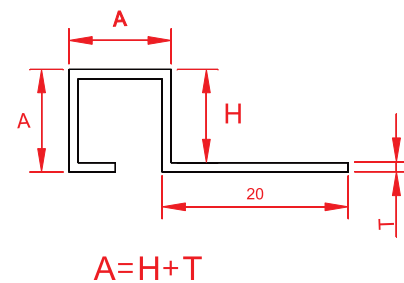

Stainless Steel 304/316      304 316

ART.	Hight (mm)	Length (mm)	Thickness (mm)	Color	Remark备注
SBP110-10H	10	2440	0.8, 1.0	1S, 2S, 3S, 4S, 1B, 2B, 3B, 4B	Sizes can be customized.
SBP110-12H	12	2440	0.8, 1.0	Color option refer to P2. P2	
SBP110-14H	14	2440	0.8, 1.0		

# Corner Protection Profiles Thanh bảo vệ góc

For wall corner covers



**SBP025**

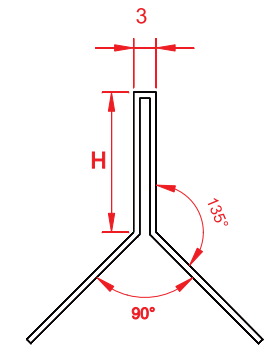

Stainless Steel 304/316      304 316

ART.	Hight (mm)	Length (mm)	Thickness (mm)	Color	Remark
SBP025-12H	12	2440	0.8, 1.0	1S, 2S, 3S, 4S, 1B, 2B, 3B, 4B	Sizes can be customized.
SBP025-14.5H	14.5	2440	0.8, 1.0	Color option refer to P2. P2	
SBP025-17H	17	2440	0.8, 1.0		



**SB020**

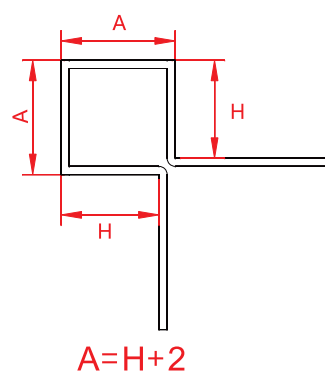

Stainless Steel 304/316      304 316

ART.	Hight (mm)	Length (mm)	Thickness (mm)	Color	Remark
SB020-10H	10	2440	0.8, 1.0	1S, 2S, 3S, 4S, 1B, 2B, 3B, 4B	Sizes can be customized.
SB020-12H	12	2440	0.8, 1.0	Color option refer to P2. P2	
SB020-14H	14	2440	0.8, 1.0		



**SB048**

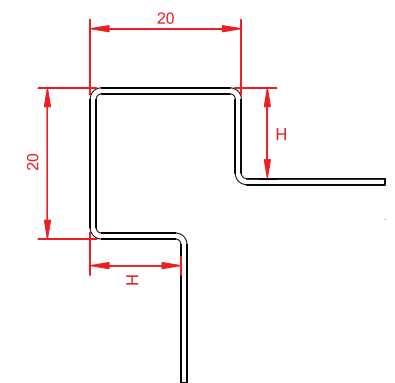

Stainless Steel 304/316      304 316

ART.	Hight (mm)	Length (mm)	Thickness (mm)	Color	Remark
SB048-8H	8	2440	0.6, 0.8, 1.0	1S, 2S, 3S, 4S, 1B, 2B, 3B, 4B	Sizes can be customized.
SB048-10H	10	2440	0.6, 0.8, 1.0	Color option refer to P2. P2	
SB048-12.5H	12.5	2440	0.6, 0.8, 1.0		



# Corner Protection Profiles Thanh bảo vệ góc

For wall corner covers



**SA004**

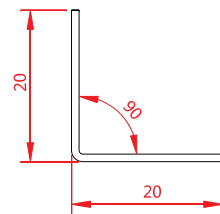

Stainless Steel 304/316      304 316

ART.	Width (mm)	Length (mm)	Thickness (mm)	Color	Remark
SA004-20W	20	2440	0.6, 0.8, 1.0	1S, 2S, 3S, 4S, 1B, 2B, 3B, 4B Color option refer to P2. P2	Sizes can be customized.

# Corner Protection Profiles Thanh bảo vệ góc

For wall corner covers



**SA027**

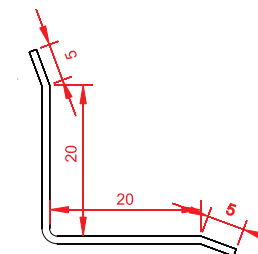

Stainless Steel 304/316      304 316

ART.	Width (mm)	Length (mm)	Thickness (mm)	Color	Remark
SA027-25W	25	2440	0.6, 0.8, 1.0	1S, 2S, 3S, 4S, 1B, 2B, 3B, 4B Color option refer to P2.	Sizes can be customized.

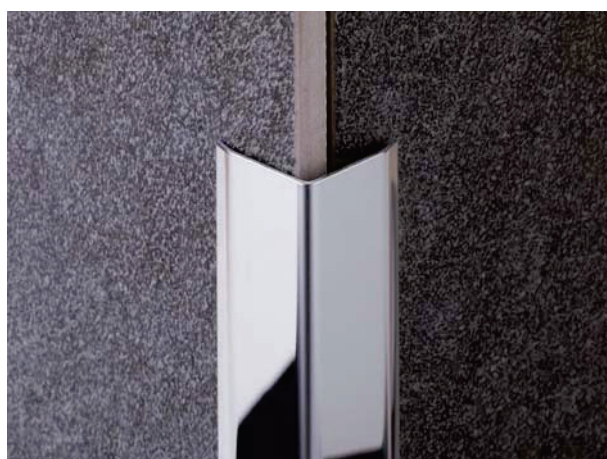

**SA012**

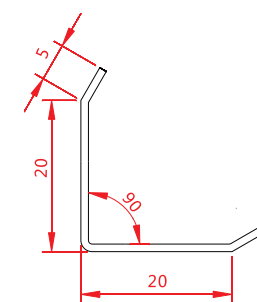

Stainless Steel 304/316      304 316

ART.	Width (mm)	Length (mm)	Thickness厚度 (mm)	Color颜色	Remark备注
SA012-25W	25	2440	0.6, 0.8, 1.0	1S, 2S, 3S, 4S, 1B, 2B, 3B, 4B Color option refer to P2. P2	Sizes can be customized.



## Countertop Profiles Thanh góc bàn

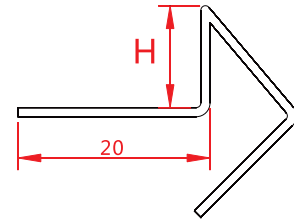

**SL021**

Stainless Steel 304/316      304 316

ART.	Hight (mm)	Length (mm)	Thickness (mm)	Color	Remark
SL021-10H	10	2440	0.8, 1.0	1S, 2S, 3S, 4S, 1B, 2B, 3B, 4B	Sizes can be customized.
SL021-12H	12	2440	0.8, 1.0	Color option refer to P2. P2	
SL021-14H	14	2440	0.8, 1.0		

## Transition Profiles Thanh T

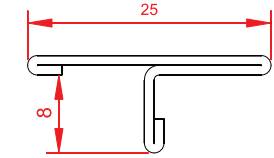
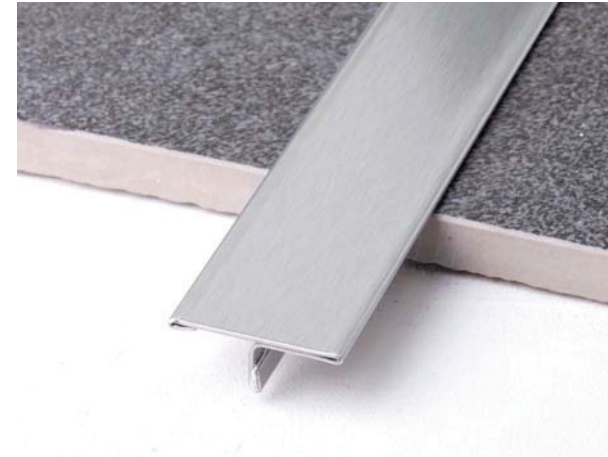

**ST015**

Stainless Steel 304/316      304 316

ART.	Hight (mm)	Length (mm)	Thickness (mm)	Color	Remark
ST015-8H	8	2440	0.6, 0.8	1S, 2S, 3S, 4S, 1B, 2B, 3B, 4B	Color option refer to P2. P2 Sizes can be customized.

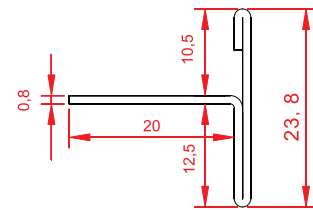

**SL026**

Stainless Steel 304/316      304 316

ART.	Hight (mm)	Length (mm)	Thickness (mm)	Color	Remark
SL026	10.5 12/5	2440	0.6, 0.8	1S, 2S, 3S, 4S, 1B, 2B, 3B, 4B	Color option refer to P2. P2 Sizes can be customized.

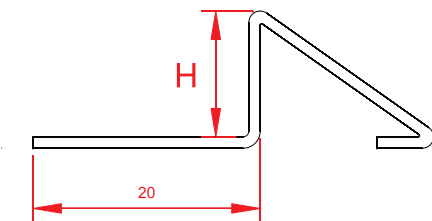

**SL028**

Stainless Steel 304/316      304 316

ART.	Hight (mm)	Length (mm)	Thickness (mm)	Color	Remark
SL028-8H	8	2440	0.8, 1.0	1S, 2S, 3S, 4S, 1B, 2B, 3B, 4B	Color option refer to P2. P2 Sizes can be customized.
SL028-10H	10	2440	0.8, 1.0		
SL028-12H	12	2440	0.8, 1.0		

## Cove-Shaped Profiles Thanh góc trong

For wall /floor connections

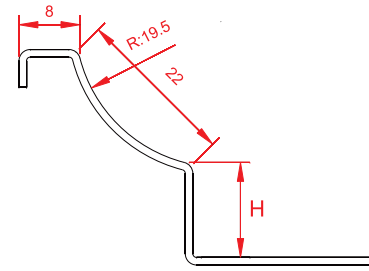

**SY045**

Stainless Steel 304/316      304 316

ART.	Hight (mm)	Length (mm)	Thickness (mm)	Color	Remark
SY045-10H	10	2440	0.6, 0.8, 1.0	1S, 2S, 3S, 4S, 1B, 2B, 3B, 4B	Sizes can be customized.
SY045-12H	12	2440	0.6, 0.8, 1.0	Color option refer to P2. P2	
SY045-14H	14	2440	0.6, 0.8, 1.0		

## Stair Nosing Profile Thanh chống trượt bậc thang

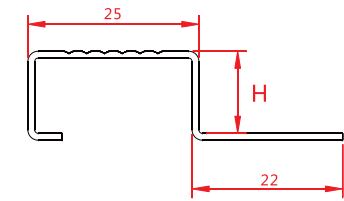

**SB022**

Stainless Steel 304 316      304 316

ART.	Hight (mm)	Length (mm)	Thickness (mm)	Color	Remark
SB022-10H	10	2440	0.8, 1.0	1S, 2S, 3S, 4S, 1B, 2B, 3B, 4B	Sizes can be customized.
SB022-12H	12	2440	0.8, 1.0	Color option refer to P2. P2	
SB022-14H	14	2440	0.8, 1.0		

## Skirting Profile Len tường

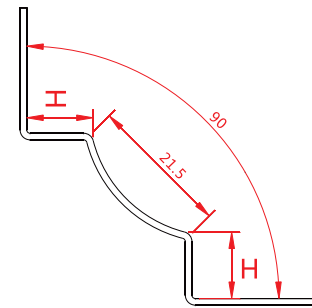

**SY023**

Stainless Steel 304/316      304 316

ART.	Hight (mm)	Length (mm)	Thickness (mm)	Color	Remark
SY023-8H	8	2440	0.6, 0.8, 1.0	1S, 2S, 3S, 4S, 1B, 2B, 3B, 4B	Sizes can be customized.
SY023-10H	10	2440	0.6, 0.8, 1.0	Color option refer to P2. P2	
SY023-12H	12	2440	0.6, 0.8, 1.0		

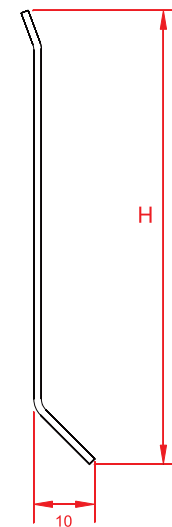

**SY044**

Stainless Steel 304/316      304 316

ART.	Hight (mm)	Length (mm)	Thickness (mm)	Color	Remark
SY044-60H	60	2440	0.8, 1.0	1S, 2S, 3S, 4S, 1B, 2B, 3B, 4B	Sizes can be customized.
SY044-80H	80	2440	0.8, 1.0	Color option refer to P2. P2	
SY044-100H	100	2440	0.8, 1.0		

# Glass Holder Profiles Thanh giữ kính



**SB041**

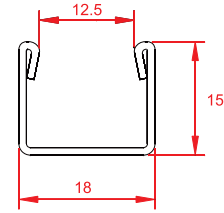

Stainless Steel 304/316      304 316

ART.	Width (mm)	Length (mm)	Thickness (mm)	Color	Remark
SB041-12.5W	12.5	2440	0.8, 1.0	1S, 2S, 3S, 4S, 1B, 2B, 3B, 4B Color option refer to P2. P2	Sizes can be customized.

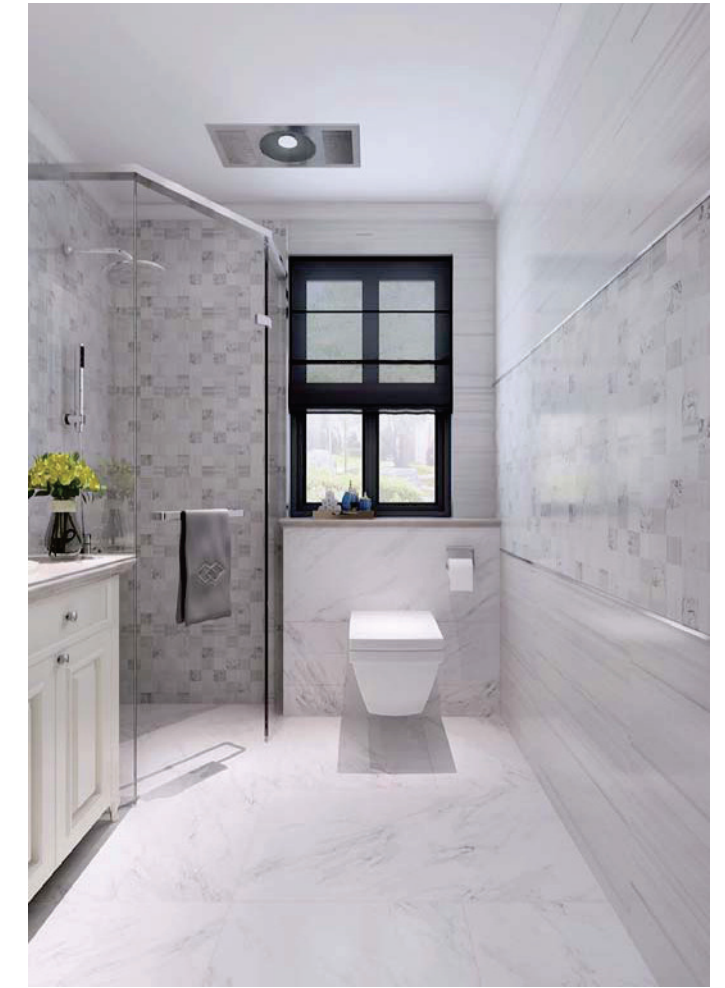

**SB043**

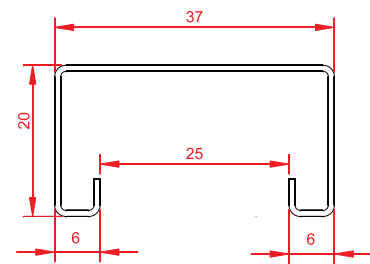

Stainless Steel 304/316      304 316

ART.	Width (mm)	Length (mm)	Thickness (mm)	Color	Remark
SB043-25W	12	2440	0.8, 1.0	1S, 2S, 3S, 4S, 1B, 2B, 3B, 4B Color option refer to P2. P2	Sizes can be customized.

